

LAS 1200 MD THA16

Technical documentation

Date of issue: 02/2013



ULT 1200

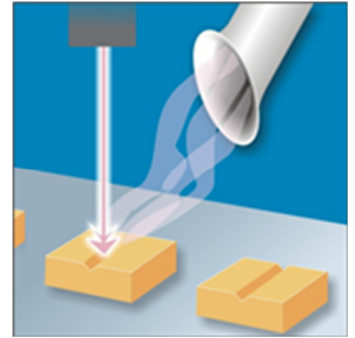

**Clean air,
high performance.**

**LAS-series, mobile
air extraction and
filtration units for
laser smoke.**



Air handling equipment for environmental and health protection

Technical documentation

Air extraction and filtration unit

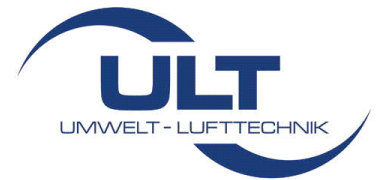

LAS 1200 MD THA16

Use and application



laser smoke

The **LAS 1200 MD THA16** is suitable for collecting and filtering dry and non-combustible types of dust contained in non-explosive air mixtures produced during laser machining. Any emitted and partially unhealthy **types of dust** ought to be extracted by collecting elements directly at their place of origin and filtered by the LAS 1200 MD THA16. The material of the filter elements ensures effective filtering out of the various dust particle sizes. The combination of the five filtration levels guarantees a separation efficiency of > 99 % by multiple cleaning, provided the filter elements are exchanged regularly.

Examples

- ⇒ laser cutting
- ⇒ laser engraving
- ⇒ laser structuring

ULT 1200 modular air extraction and filtration unit

mobile unit,
with storage filter system
robust steel housing, powder coated
RAL 7035 light grey / RAL 7001 silver-grey



Filter system:

Storage filter system
Filters which are replaced once they are saturated.

Filter technology:

Main filter module

- (1) Expanded metal filter
metal knitting, spark protection filter
- (2) Pocket filter F7
filter class: F7 fine dust filter according to DIN EN 779
- (3) Filter mat M5
filter class: M5 medium dust filter according to DIN EN 779
- (4) Particle filter cassette H13
filter class: H13 HEPA-filter according to DIN EN 1822
- (5) Adsorption filter cassette A16
filter medium: activated charcoal (16 kg)

Technical documentation

Air extraction and filtration unit



LAS 1200 MD THA16

LAS 1200.0-MD.bb.cc.6006

Parameter	unit	-MD.18.10.	
Max. air flow	m ³ /h	1,500	
Max. vacuum	Pa	3,250	
Nominal capacity	m ³ /h / Pa	1,000 / 1,700	
Motor-nominal power	kW	0,86	
Nominal voltage	V	1~ 230	
Nominal current	A	3.8	
Frequency	Hz	50 / 60	
Protection class	IP	54	
Type blower		EC-blower	
Noise level (at 50 - 100%)	dB(A)	60	
Air flow controller		Incl.	
Loaded particle filter indicator	optical	Incl.	
SUB D9 interface	(1*)	optional	
Digital control integrated	(2*)	optional	
Remote digital control		optional	
Air outlet DN 200	(3*)	optional	
Air intake options		1x Ø 150 mm take off	
	position	backside of the unit	
	position	1x Ø 160 mm take off	
Air outlet		air exhaust louver	
	position	lower rear side	
Width	mm	790	
Depth	mm	820	
Height	mm	1,340	
Weight	kgs	approx. 170	
Length of power cable	m	5	
Filter system		filter system: storage filter	
		Filter set consisting of:	
	(1)	Expanded metal filter	ULT 02.0.676
	(2)	Pocket filter F7	ULT 02.0.612
	(3)	Filter mat M5	ULT 02.0.652
	(4)	Particle filter cassette H13	ULT 02.1.619
(5)	Adsorption filter cassette A16	ULT 02.1.606	

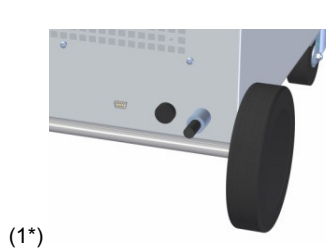

(1*)

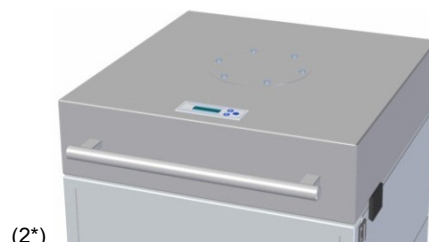

(2*)

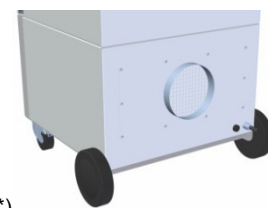

(3*)

LAS 1200 MD THA16



laser smoke

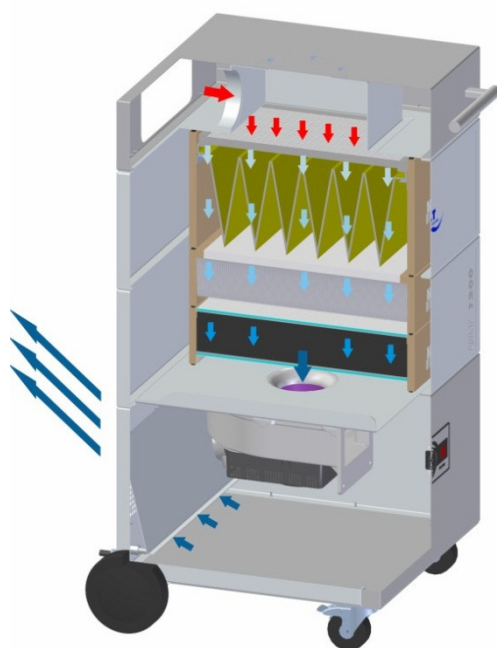

-  raw gas
-  filtration
-  clean gas

Functional principle:

At the **clean-air side** of the filter, a vacuum generator with a high pressure reserve produces a volume flow matched to the respective application. This volume flow can be individually and infinitely variably regulated. Thus, the polluted air will be reliably extracted.

The **particles** are separated and held back at the first filtration level in multiple stages. **Gaseous and vaporous air pollutants** are separated (adsorbed) in an activated charcoal filter. The filtering effect of activated charcoal is based on adsorption, i. e. an accumulation of substances (to be filtered out) on the surface of the activated charcoal.

Storage filter system

Filters which are replaced once they are saturated.

Filtration set complete

- | | |
|-------------------------------|--|
| (1) spark protection | Expanded metal filter |
| (2) fine dust filter | Pocket filter F7 |
| (3) protection filter | Filter mat M5 |
| (4) particulate filter | Aerosol filter H13 |
| (5) gas filtration | Adsorption filter cassette A16
(16 kg activated carbon) |

This excellent filter efficiency makes it possible to recirculate the **filtered air** and reduce energy costs.

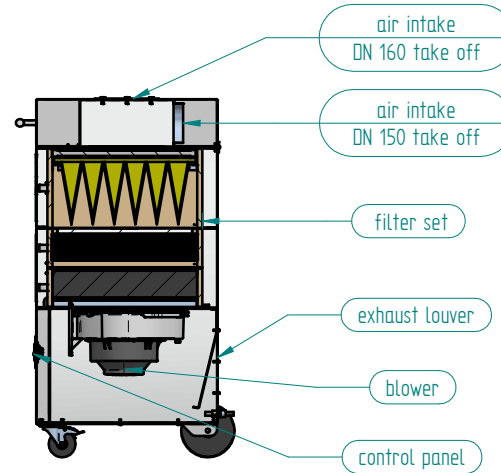
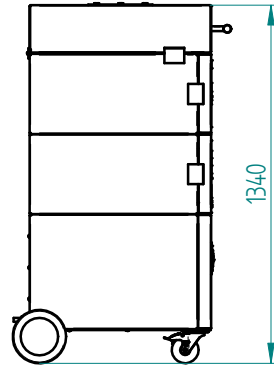
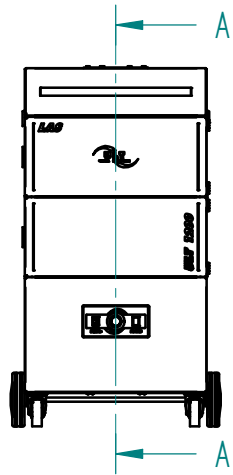

Schnitt A-A

filter set consisting of:

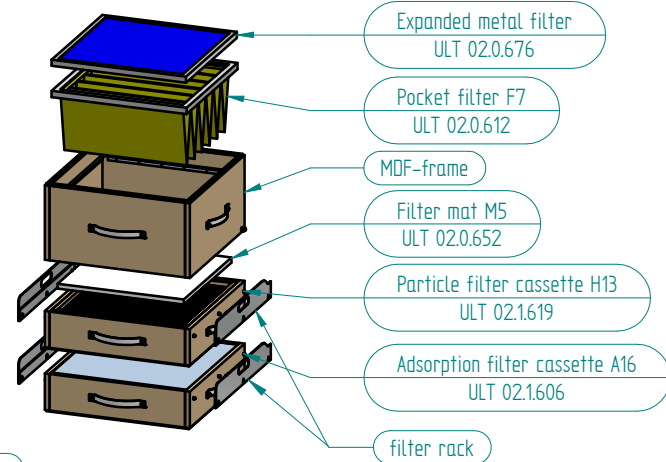
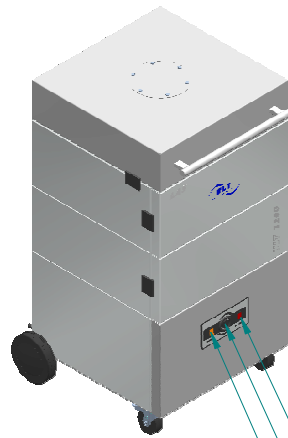
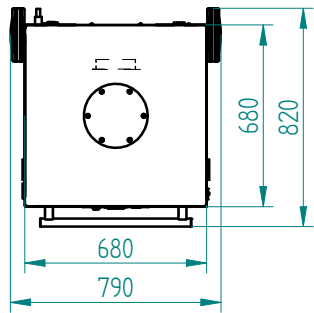

Weitere Maße sind dem 3D-Datensatz zu entnehmen. Für die Zeichnung behalten wir uns alle Rechte vor.
Other measure are to be taken from the 3D record. For the drawing we reserve ourselves all rights.



				ULT AG Am Gopelreich 1 D-02708 Lobau		designation LAS 1200 MD THA16 / 1.000 m³/h-VF	
				D-02708 Lobau		LAS 1200.0-MD.18.10.6006	
				drawing number:		scale:	
001	base	14.02.13	JSACZ	2013	date	name	1 : 20
issue	revision	day	name	edit.	14.02.	JSACZ	
				verf.		drawing number: ULT 1200_00_130_001	
				Norm			